

Stair Climbing System

S-max

User's Manual



CE Declaration of conformity

The company AAT Alber Antriebstechnik GmbH herewith declares that the products of the stair climbing system **s-max** were developed and manufactured in concordance with the current regulations of the European Union, EEC Guidelines 93/42/EWG.

This declaration becomes void if the above mentioned devices have been altered without the consent of Alber Antriebstechnik GmbH.

CE

Signature of the manufacturer:



Markus Alber
Managing shareholder
AAT Alber Antriebstechnik GmbH



The stair climbing system **s-max** has been tested successfully according to the ISO/FDIS 7176-23 by the Technical University Berlin.



AAT Alber Antriebstechnik GmbH

Postfach 10 05 60 · 72426 Albstadt
Tel.: +49 - 74 31 - 12 95 0 · Fax.: +49 - 74 31 - 12 95 35
info@aat-gmbh.com

www.aat-gmbh.com

Table of contents

	CE Declaration of conformity	2
	Table of contents	3
1	General information	5
1.1	Instruction	5
1.2	Care and maintenance	5
1.3	Warranty and liability	5
2	Description of the product	6
2.1	Adequate use.	6
2.2	Features of the S-max	7
2.3	Technical data	7
3	Assembly	8
3.1	Handle	8
3.2	Attach the battery pack	9
3.3	Detach the battery pack	9
3.4	Adjust the handle.	10
4	Safety instructions	11
4.1	Instruction	11
4.2	Safety brakes	11
4.3	Lining of the climber's rollers	11
4.4	Lifting capacity.	11
4.5	Care and maintenance	11
4.6	Condition of paths, walkways etc.	11
4.7	Charge of the batteries	11
5	Operation	12
5.1	Maximum lifting capacity	12
5.2	Battery pack	12
5.3	Control lights.	12
5.4	Safety brakes	12
5.5	Rollers attached to climber	12
6	Instructions for operation	13
6.1	Operational components	13
6.2	Single step control	14
6.3	Climber	14
6.4	Safety brakes	15
6.5	Attach S-max to or detach it from the wheelchair	16
6.6	Transporting a person with the S-max	19
6.7	Operation on a slope	20
6.8	Climbing upstairs	21
6.9	Climbing downstairs	23
6.10	Laying the S-max on the stairs	24
6.11	Transportation	24

7	Accessories	25
7.1	Battery pack	25
7.2	Automatic charger	25
7.3	Voltage converter for your vehicle	25
8	Care and maintenance	26
8.1	Stair climber <i>S-max</i>	26
8.2	Charger	26
8.3	Battery pack	27
8.4	Electrical fuse	29
8.5	Brake lining	30
8.6	Check/exchange the climber's rollers	30
8.7	Cleaning	30
9	Warranty and liability	31
9.1	Warranty	31
9.2	Liability	31

1 General information

Congratulations! With the acquisition of this stair climbing system you have a device that will quickly become a reliable and indispensable partner in transporting physically disabled people.

With the **S-max** you are able to transport persons safely and effortlessly up- and downstairs; even winding stairs are no problem for the **S-max**.

Driving on slopes is also possible. The safety brakes on both sides of the **S-max** ensure your safety .

Naturally the **S-max** is also suitable to drive on level ground. The device is lightweight, flexible and does not take up much space.

1.1 Instruction

This user's manual will instruct you step by step about the safe and adequate use of the **S-max**. Operating the **S-max** takes a certain skill.

In the interest of your safety only trained personnel may use the **S-max**.

-  Please read this user's manual carefully and particularly take note of the safety instructions before you use the **S-max** for the first time.

1.2 Care and maintenance

One of the most important aspects concerning the maintenance of the **S-max** charging the sealed lead acid batteries. They are part of the battery pack and must be charged every time after using the device.

Other than that your **S-max** does not need much care or maintenance. More extensive instructions you find in chapter 8.

1.3 Warranty and liability

For damage that was caused by inadequate use disregarding this manual we assume no liability whatsoever. (Please read chapter 9 for more detailed information concerning warranty and liability).



2 Description of the product

2.1 Adequate use

Please use the **S-max** exclusively for the transportation of physically disabled persons.

Said persons should be able to sit properly without help, otherwise you should secure them with a safety belt.

The latter is an accessory available at AAT Alber Antriebstechnik GmbH.

- ☞ In the interest of your safety you may not use the stair climbing device **S-max** on escalators or moving belts!
- ☞ Transporting other kinds of loads is explicitly prohibited!
- ☞ Please do not use the **S-max** in the rain or generally in wet conditions due to the following potential safety hazards, e.g. danger of slipping, restricted braking effect etc.



Mastering stairs



Driving on slopes



Driving on level ground

2.2 Features of the S-max

- 1 = control unit
- 2 = locking knob for horizontal adjustment
- 3 = handle
- 4 = locking knob for height adjustment
- 5 = column
- 6 = locking knob for column
- 7 = handle unit
- 8 = single step switch and control lights
- 9 = upper rod
- 10 = lower rod
- 11 = main wheel with safety brakes on both sides
- 12 = battery pack
- 13 = climber
- 14 = climbing unit

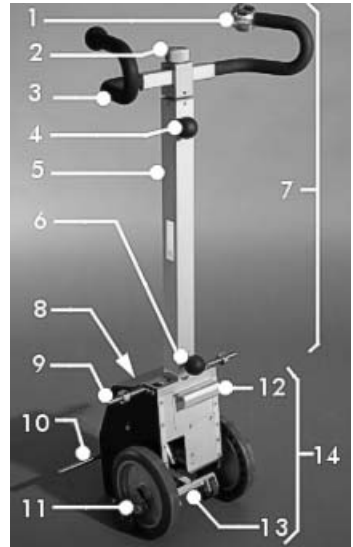

2.3 Technical data

measurements	height = 1200 mm, max. 1650 mm width: handle 520 mm, climbing unit = 330 mm depth: climbing unit = 320 mm, handle = 220 mm
weight	climbing unit = 14,5 kg (32 lbs) handle = 4 kg (8,8 lbs) battery pack = 3,5 kg (7,7 lbs) total weight = 22 kg (48,5 lbs)
maximum lifting capacity	120 kg (264,6 lbs)
batteries	2 x 12 V / 3,3 Ah sealed lead acid
direct current motor	24 V
climbing speed	8 - 23 steps / minute, continuously adjustable
capacity with one battery pack	up to 300 steps, depending on the load
Maximum height of step	22 cm
noise level	the device's A weighted noise level lies typically below 70 dB (A)
vibrations	the weighted RMS value of acceleration the upper body is exposed to lies typically below 2.5 m/s ²

3 Assembly

In a few quick steps you can assemble the **S-max** by means of several fixtures and tightening knobs. Disassembly is just as easy.

3.1 Handle

First connect the handle ❶ with the climbing unit ❷

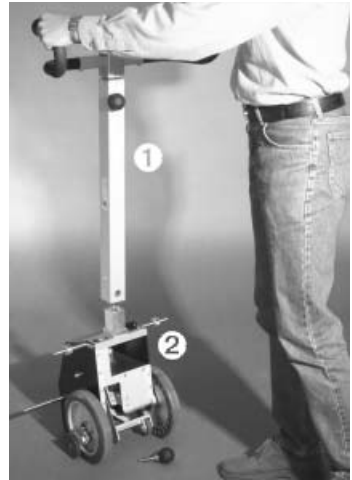

by inserting the column into the holding device ❸ on the climbing unit.

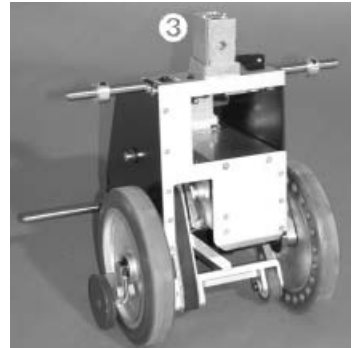

A 9-pin Sub-D socket connector ❹ located in the climbing unit's holding device makes the electrical connection.

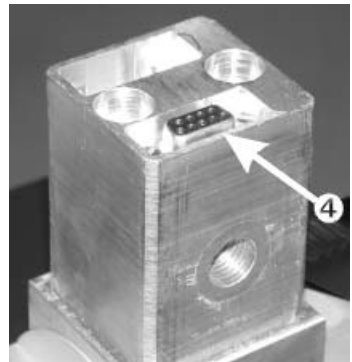

Secure the connection with the tightening knob ❶.

- 👉 Please always make sure that the handle is safely connected to the climbing unit.

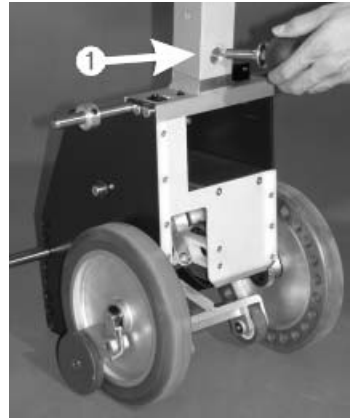

3.2 Attach the battery pack

Push the battery pack ❷ sideways into the climbing unit; once connected it is automatically locked.

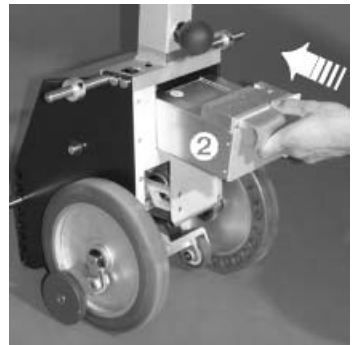

3.3 Detach the battery pack

Push down the locking lever ❸ on the climbing unit and take out the battery pack.



3.4 Adjust the handle

3.4.1 Adjust the height of the handle

Release the tightening knob ① by turning counter clockwise. Pull out the handles ② to the appropriate height (maximum shoulder height). Then retighten the tightening knob.

 Please always make sure that the tightening knob is secure.

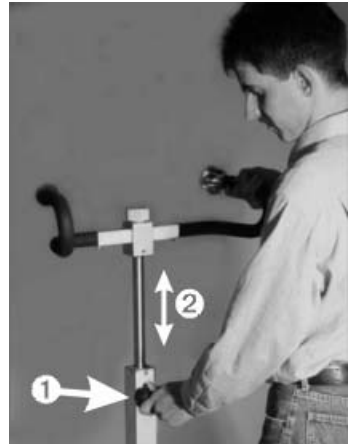

3.4.2 Adjust the handle horizontally

In very narrow staircases or on winding stairs the handles may hit the wall. To be able to drive on such stairs the handles can be adjusted horizontally.

Release the tightening knob ③ counter clockwise and adjust the handles ④ horizontally to the desired position. Then retighten the tightening knob.

 Please make sure that the tightening knob is secure.

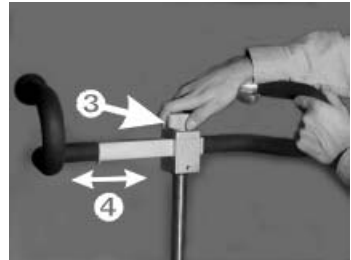

4 Safety instructions

 For the safe operation of the **S-max** it is highly important that you pay close attention to all instructions regarding operation and safety stressed in this user's manual.

4.1 Instruction: The **S-max** may only be operated by trained personnel. In addition, the operator should be capable of lifting 1/3 of his or her own weight. Minors are not allowed to use the **S-max**; exempt from the above are adolescents over 16 years of age who have been trained under supervision to operate the **S-max**. While using the **S-max** you should always wear good shoes that do not slip.

4.2 Safety brakes: Please check the safety brakes each time before using the **S-max** (see also chapter 6.4 and 8.5). The safety brakes, particularly the knurled surface of the brake drums in the wheel rims, must be cleaned weekly with alcohol to ensure the optimum braking effect.

 Never use suds or greasy cleaners. After cleaning the safety brakes must be checked as described in chapter 6.4

4.3 Lining of the climber's rollers: Please check regularly whether the lining of each roller is undamaged.

4.4 Lifting capacity: The stated maximum lifting capacity of 120 kg (264,6 lbs) - chair included - may not be exceeded. Please also read chapter 5.1.

 You may under no circumstances use the **S-max** to transport goods.

4.5 Care and maintenance: Please make sure that you charge the battery pack after each use of the **S-max**. When the **S-max** is at a standstill for a while, please turn the device off, i.e. the ON/Off switch needs to be on 0. If the working elements of the device block, turn the **S-max** off immediately.

 Repairs may be done by authorized dealers or the manufacturer only. Please exclusively use AAT Alber parts and accessories.

Please note the extensive care and maintenance instructions in chapter 8.

4.6 Condition of paths, walkways etc.: Please make sure that the paths and walkways you use with the **S-max** are free of obstacles and not slippery. Avoid operation on damaged stair linings, snow, ice, etc.

 The **S-max** may not be used in wet and rainy conditions.

4.7 Charge of the batteries: You should only use the **S-max** with fully charged batteries. In case the batteries run low on the stairs (a sequence of 2 flashes repeated every 2.5 seconds) the available charge of the batteries is sufficient to transport the person safely to the bottom of the stairs. Driving downstairs the motor works as a generator, thus recharging the batteries. The potential steps downward, therefore, are not limited.

5 Operation

5.1 Stay within the maximum lifting capacity

Please make sure that the maximum lifting capacity of 120 kg (264,6 lbs) - including the chair - is not exceeded.

5.2 Battery pack

Please make sure that the sealed lead acid batteries ❶ are fully charged before you use the S-max for the first time (extensive instructions you find in chapter 8.3.).

5.3 Control light

After turning on the device, the control light ❷ should light up and stay on. A flashing control light indicates malfunction.

Further information on malfunction you find in chapter 6.1.4

5.4 Safety brakes

Before operating the S-max check the safety brakes ❸ every single time.

Extensive instructions you find in chapter 6.4.

5.5 Rollers attached to climber

Please check regularly whether the linings on both rollers ❹ attached to the climber are intact.

You find further information in chapter 8.6.

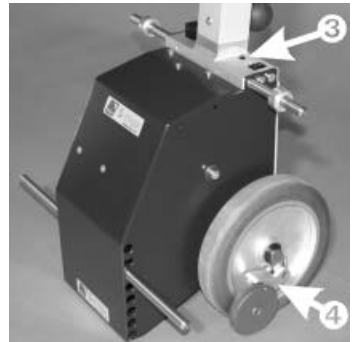
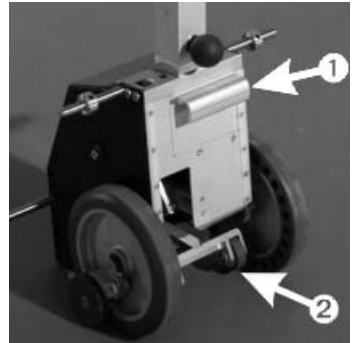

6 Instructions for operation

Before we get to the actual instructions for operation, we would like to introduce the *S-max*'s most important components to you.

6.1 Operational components

The control unit **1** is situated on the right handle and consists of an ON/OFF switch **2**, an UP/DOWN switch **3**, and a speed control **4**.

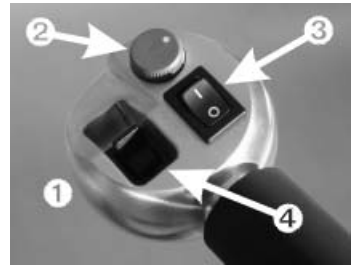

6.1.1 ON/OFF switch

If the *S-max* is at a standstill for some time, please turn the device off, i.e. the switch must be on 0.

 The *S-max* is equipped with an electronic turn-off mechanism, i.e. if you forget to turn off the *S-max* and the device is not used for 5 minutes, it turns itself off automatically. In such case you need to turn the device first OFF and then ON again.

6.1.2 UP/DOWN switch

With the UP/DOWN switch you activate the climbing mechanism up- or downstairs.

6.1.3 Speed control

The speed control enables you to adjust the speed continuously.

6.1.4 Control light to indicate malfunction

After turning on the *S-max* the green control light **5** lights up and remains lit, which indicates that the stair climbing system is in order and ready to use.

Potential malfunction is indicated by a light diode. After a period of 3 seconds each time a blinking signal is repeated.



In case of malfunction, turn the device first off and then on again. If there is still an indication of malfunction, charge the batteries in case of low battery charge. For all other cases of malfunction, please call your local dealer.

Number of flashes	Indicated malfunction
1	overload of the device
2	battery pack, undervoltage
3	overvoltage
4	UP/DOWN switch or its supply line is damaged
5	defective electromagnetic brake
6	malfunction of electronics

6.2 Single step control

The single step switch ❶ is located on the climbing unit. To practice and particularly to master winding stairs, please use the single step mode (switch position I down = ON).

If you activate the UP/DOWN switch in that mode, the device will climb only one step at a time. The climbing system stops in the correct position, even if you keep pressing the UP/DOWN switch. You can take your time to move the main wheels to the next step's edge.

👉 To continue climbing you first need to release the UP/DOWN switch before pressing it again.

6.3 Climber

The climber ❷ must be pulled in to topmost position by means of the UP/DOWN switch if you want to:

- drive on level ground and on slopes
- check the safety brakes
- begin climbing upstairs or downstairs

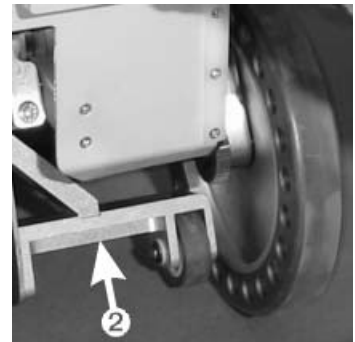

6.4 Safety brakes

There are safety brakes ❶ located on the climbing unit on both sides.

- 👉 Please check the safety brakes each time before you use the *S-max*.

You may check the brake effect either on top of the stairs or on level ground as described in 6.4.1 and 6.4.2.

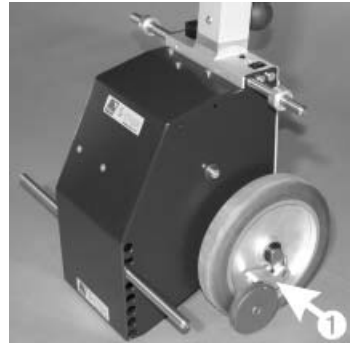

6.4.1 Test the required brake effect

Pull in the climber to its upmost position and tilt the *S-max* backwards approximately to a 45 degree angle of the column ❷

If the *S-max* cannot be pushed forward ❸ by the handles in said position, but merely rolls backwards ❹, then the required brake effect for the safe operation of the *S-max* is granted.

- 👉 If the required brake effect is not guaranteed, you may, under no circumstances, use the *S-max* any more. Please contact your local AAT Alber dealer or the manufacturer immediately

6.4.2 Test the required brake effect at the top edge of the stairs

Pull in the climber to its upmost position and tilt the device backwards to its regular climbing position. Drive forward to the first step's edge. If you cannot push the device over the edge of the step, the required braking effect for a safe operation of the *S-max* is granted.

- 👉 If the required brake effect is not guaranteed, you may, under no circumstances, use the *S-max* any more. Please contact your local AAT Alber dealer or the manufacturer immediately.



6.5 Attach the S-max to or detach it from the wheelchair

6.5.1 Bracket on the wheelchair

The wheelchair must be equipped with a bracket in order to attach the S-max to the wheelchair.

AAT Alber Antriebstechnik GmbH offers a universally applicable mounting system. At your local Alber dealership or directly at Alber an upper ① and lower ② bracket is affixed to both sides of your wheelchair's frame.

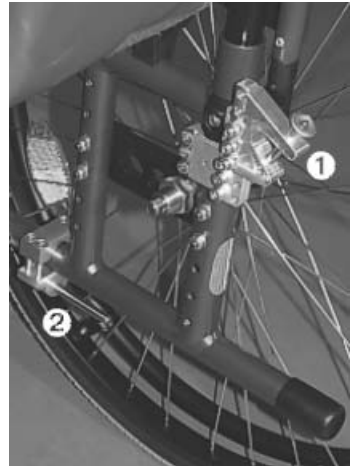

6.5.2 Bracket on the S-max

On your S-max you find an upper ③ and lower ④ rod. To adjust the lower rod's height there are several vertical holes drilled into the housing of the S-max.

Your local AAT Alber dealership or the company AAT Alber Antriebstechnik GmbH adjusts the height at which the S-max is mounted to your type of wheelchair.

On both sides of the upper rod there are rings ⑤. The position of said rings are also adjusted to your type of wheelchair.

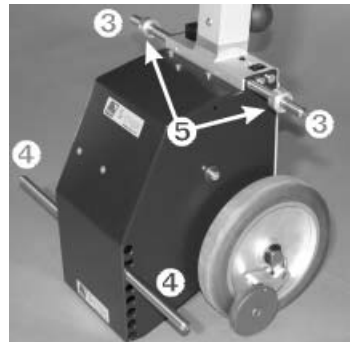

6.5.3 Insert the S-max into the lower bracket on the wheelchair

1. Please use the locking brakes of your wheelchair to avoid any movement of the chair while the S-max is being mounted.
2. Pull in the S-max's climber entirely.
3. Tilt the S-max slightly backwards and drive the device in the middle of the wheelchair's back.
4. At this point push the S-max forward until the lower rod ❶ is inserted all the way into the lower bracket ❷ on the wheelchair.

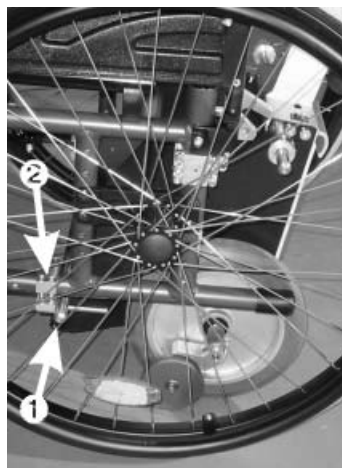

6.5.4 Insert the S-max into the upper bracket on the wheelchair

1. Select the lowest climbing speed.
2. Push the UP/DOWN switch, direction UP (never DOWN) so that the climber moves in the direction of the attendant backward and downward.
3. As soon as the climber touches the ground the device is lifted. If the S-max is positioned in the middle, the upper rod moves into the claws of the upper bracket ❸. The rings are now at the inner sides of the brackets.
4. As soon as the rod is all the way in the bracket, the wheelchair is lifted. Release the UP/DOWN switch when the wheelchair's wheels are approximately 1cm off the ground.

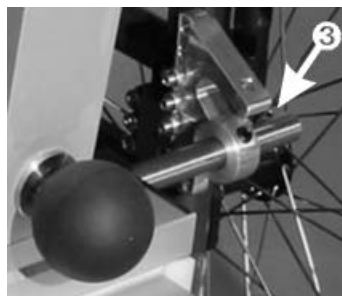

6.5.5 Fix the S-max to the wheelchair

1. Take one of the quick pins ❹ and with your thumb push down the locking bolt in the middle.
2. Put the quick pin all the way into the drilled hole ❺ of one of the upper brackets on the wheelchair and release the locking bolt.
3. Now take the other locking pin and put it into the other bracket on the wheelchair as described in point 2.

Only by using quick pins a strong connection between S-max and wheelchair is secured.

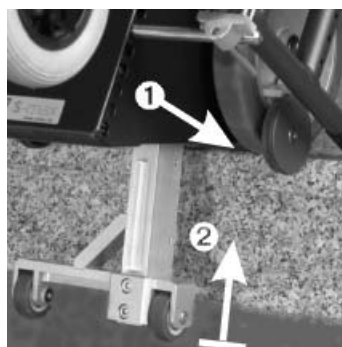

6.5.6 Remove the wheelchair's wheels

To move the wheelchair with the *S-max* up- and downstairs you need to remove the wheelchair's big wheels.

The wheels must be lifted approximately 1 cm off the floor. After mounting the *S-max* to the wheelchair with the quick pins, if necessary, push the UP/DOWN switch in direction UP until the device plus chair is lifted accordingly by the climber.

1. The axles of the wheelchair's wheels are equipped with a quick release system. With your index finger push in the locking bolt in the middle of the quick release system, which releases the connection to the wheel so that the wheel can be removed.
2. Please remove the wheelchair's wheels one by one accordingly.

Finally pull in the climber entirely. At this point the wheelchair plus *S-max* is ready to use.



6.5.7 Remove the *S-max* from the wheelchair

Push the UP/DOWN switch in direction UP (never DOWN) so that the climber moves backward and downward in the direction of the user. Device plus wheelchair is lifted as soon as the climber touches the ground.

Release the UP/DOWN switch as soon as the wheelchair is lifted high enough to mount the big wheels (this is already possible at 3/4 of the highest position - as you can see in the picture on the right).

Insert the wheels and employ the locking brakes.

Remove both quick pins from the upper brackets (remember pushing in the locking bolts).

Now push the UP/DOWN switch, direction DOWN, pull in the climber entirely and drive the *S-max* backwards away from the wheelchair. In case the *S-max* ever gets caught at the lower bracket while driving backwards, push the handle slightly down and forward, then try again.



6.6 Transporting a person with the S-max

- 👉 Please practice driving with the S-max on level ground, slopes and climbing up- and downstairs at first without a person sitting in the chair!

We suggest that you practice climbing up- and downstairs with the single step mode activated (see chapter 6.2). Also choose the lowest climbing speed for practicing (see chapter 6.1.3)

- 👉 Please do not exceed the maximum lifting capacity (see chapter 5.1)

6.6.1 Operation on level ground

After the person has been properly seated, you may transport him or her effortlessly on level ground. Make sure that the climber is pulled in entirely.

Passing over thresholds pulling the S-max backwards is much easier than pushing it forwards over them.



6.6.2 Adjust the handle

For climbing stairs or driving on slopes, comfortably and safely, adjust the height of the handle ② approximately to the level of the operator's shoulders. Release the tightening knob ① counter clockwise and adjust the handle as desired.

- 👉 After adjusting the handle, always make sure that it is securely fastened.



6.6.3 Tilting the stair climbing system

To drive on slopes or to climb stairs you must tilt the **S-max**.

1. Turn on the **S-max** by pressing the ON/OFF switch. Press the UP/DOWN switch direction DOWN until the climber lifts the main wheels at least 1-2 cm off the floor.
2. Put your foot on the power unit's housing and tilt the **S-max** slightly toward you until you feel that the device is balanced.
3. The **S-max** is balanced if you feel neither pull nor push in the handle.

If you tilt the **S-max** further, or too much, the safety brakes engage and the **S-max** can't be moved forward any more.



6.7 Operation on a slope

To drive on a slope, make sure the handle is adjusted appropriately (see chapter 6.6.2).

Now tilt the **S-max** slightly backwards (see chapter 6.6.3) and pull in the climber entirely.

6.7.1 Downhill

Drive forward to the edge of the slope.

In order to slow down you need to tilt the **S-max** a bit more.

6.7.2 Uphill

Please drive backwards up a slope.

In order to slow down you need to tilt the **S-max** a bit more.

-  In the interest of your safety an additional person should assist.



6.8 Climbing upstairs

You may only transport a person with the **S-max** if you have been trained in using the device. Please always practice climbing stairs without a person and by activating the single step mode plus the lowest climbing speed.

 Please always check the safety brakes before using the **S-max** (see chapters 6.4 and 8.5)

 Adjust the handle to the appropriate height (see chapter 6.6.2)

1. Turn on the **S-max** by pressing the ON/OFF switch.
2. Activate the single step mode if necessary (see chapter 6.2)
3. Tilt the **S-max** slightly toward you (see chapter 6.6.3).
4. Pull in the climber to its topmost position by pressing the UP/DOWN switch (see chapter 6.3).

5. Drive backwards to the stairs **1** and move up 2 to 3 steps **2**

 Make sure that both main wheels touch the lowest step **3**

Now the **S-max** is in its initial position for climbing upstairs.

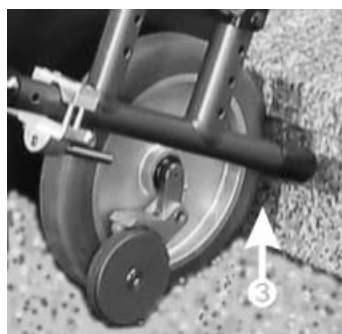

 During the climbing process always pull the **S-max** slightly towards you, so that the device automatically moves to the next higher step.

6. The climbing process takes place in two intervals. The first interval starts by pressing the UP/DOWN switch, direction UP.

The climbing process begins here with the power unit initiating the climber's movement downward **4**.

After the climber reaches the floor, it assumes the load of the main wheels while the main wheels and the frame are lifted at the same time **5**.



The first interval is finished when the main wheels ❶ touch down on the next higher step and resume the load of the climber ❷.

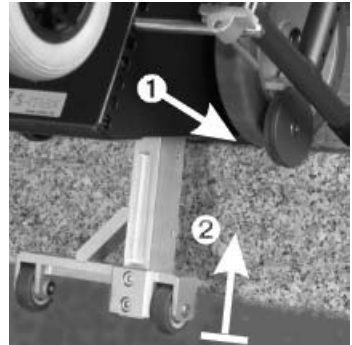

The second interval begins by pulling in the climber ❸...

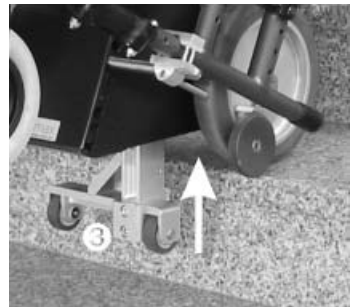

...it is finished when the climber reaches its topmost ❹ position and both main wheels touch the next step ❺.

Because the S-max is always pulled slightly backward, it rolls automatically to the next step and reaches the initial position again - both main wheels touch the next step.

If you activated the single step mode, the climbing process ends at this point.

7. To resume climbing you need to press the UP/DOWN switch once again, direction UP. At this point the climbing process repeats itself as described in point 6.

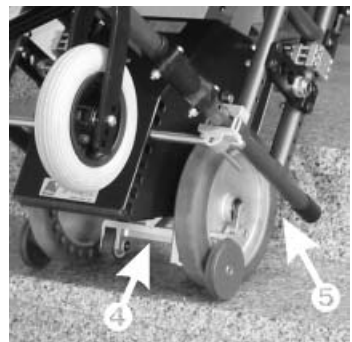

6.9 Climbing downstairs

You may only transport a person with the **S-max** if you have been trained in using the device. Please always practice climbing stairs without a person and by activating the single step mode plus the lowest climbing speed.

- 👉 Please always check the safety brakes before using the **S-max** (see chapter 6.4 and 8.5).
- 👉 Adjust the handle to the appropriate height (see chapter 6.6.2).
 1. Turn on the **S-max** by pressing the ON/OFF switch.
 2. If appropriate, activate the single step mode (see chapter 6.2).
 3. Tilt the **S-max** slightly (see chapter 6.6.3).
 4. Pull in the climber completely by means of the UP/DOWN switch (see chapter 6.3).
 5. Drive the **S-max** forward to the edge of the stairs ❶.

The sensitive brake wheels ❷ of the brakes ❸ keep the **S-max** from rolling over the edge.

6. Press the UP/DOWN switch, direction DOWN, and the descending process begins.

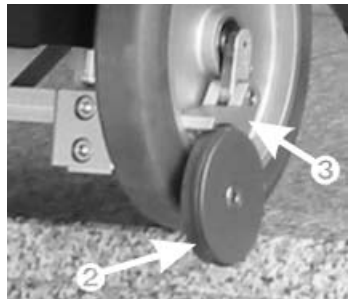

The power unit moves the climber down ❹.



When the climber reaches the next lower step ❺, it resumes the load of the main wheels, while those plus the climbing frame are lifted off the higher step ❻.

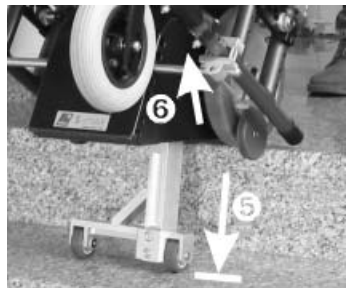

Now the main wheels and the climbing frame are moved forward ❶

Then the device is lowered by pulling up the climber ❷. You will feel a slight pull forward in the handle. Counteract this movement by briefly holding the *S-max* somewhat lower.



The main wheels touch down on the next step ❸ and resume the load of the climber ❹.

7. Again push the *S-max* all the way to the edge of the step, i.e. until the sensitive rolls of the security brakes stop the *S-max*.

If you activated the single step mode, the climbers are pulled in entirely and then the descending process ends at this point. To continue descending you need to press the UP/DOWN switch again, direction DOWN.

Climbing downstairs now repeats itself as explained in point ❸ and following.

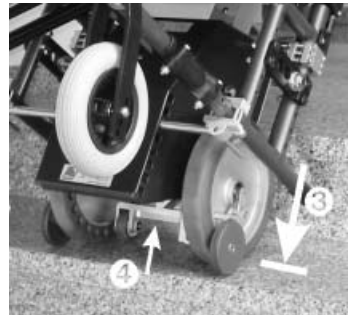

6.10 Laying the *S-max* on the stairs

In an emergency you may lay down the *S-max* on the stairs. The security brakes prevent the *S-max* from rolling down.



6.11 Transportation

For transportation you may remove the handle (see assembly chapter 3.1) and carry the climbing unit at the upper rod. Please make sure that the *S-max* is safely stored in the boot of the car.

The sealed lead acid batteries used in the *S-max* are not considered dangerous according to the IATA special guidelines A67 and GGVS Rn-Nr. 2801 A Abs.2 and admitted to air travel by DOT and IATA.

7 Accessories

7.1 Battery pack

The **s-max** works with batteries and is delivered with one battery pack with charging electronics and safety latch.

If you use the **s-max** often, i.e. if there are not sufficient breaks for the batteries to be recharged, we recommend you obtain an additional battery pack (available as an accessory). In such case one battery pack is in use while the other is being recharged at the same time.

- 👉 The battery packs should always be connected to the charger to extend its durability (see chapter 8.3).
- 👉 Please exclusively use the **AAT Alber charger** to charge your battery pack.

7.1.1 Exchange battery pack

1. Turn off the **s-max** using the ON/OFF switch.
2. Press the release button ① on top of the battery pack until it disengages. Now you pull out the battery pack at its grip ② from its housing.

Push the other fully charged battery pack into its housing. This establishes the power connection and locks the battery pack.

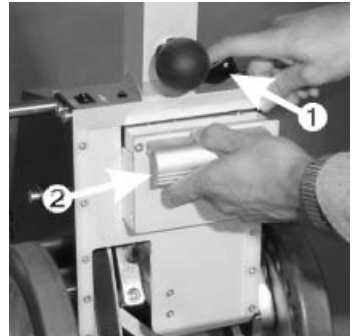
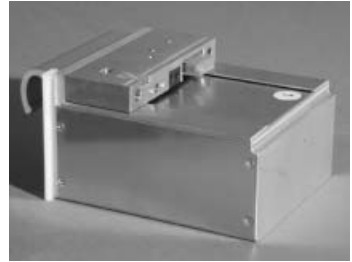

7.2 Automatic charger

The **s-max** comes with the automatic charger. The charging cable's plug ③ fits into the wall outlet socket; connect the other plug ④ to the appropriate socket on the battery pack or on the **s-max**.

This automatic charger recharges your batteries 100%. As soon as the charging process is completed, it switches to a retaining mode, thus overcharging is impossible.

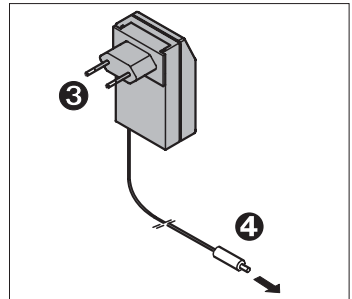

7.3 Voltage converter for your vehicle

We recommend the voltage converter for your vehicle, if you transport the stairclimber **s-max** in your car. The Alber voltage converter is designed for a 12 V electrical system. This voltage converter transforms 12 V / 24 V direct current (D.C.) into 230 V alternating current (A.C.)

The plug of the voltage converter ⑤ is plugged into the cigarette lighter in your car or into the socket of the supply system. The automatic charger's 230 V connector ⑥ is plugged into the socket ⑥ of the converter.

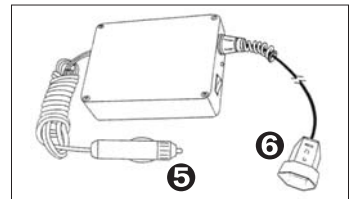

8 Care and maintenance

8.1 Stair climber *S-max*

To guarantee the safety of the *S-max* the device must be inspected every two years, even if there are no outer signs of damage or malfunction.

- 👉 In the interest of your safety repairs of any kind may only be done by personnel authorized by AAT Alber Antriebstechnik GmbH. We are happy to inform you about the contact address of the dealer closest to you.

The device itself (as opposed to the batteries) does not need any particular maintenance except for an occasional cleaning (see chapter 8.7).

8.2 Charger

Please exclusively use the AAT Alber charger to charge your battery packs.

8.2.1 Automatic charger

The charger does not need any particular maintenance.

- 👉 Please adhere to the special safety instructions supplied with the charger.

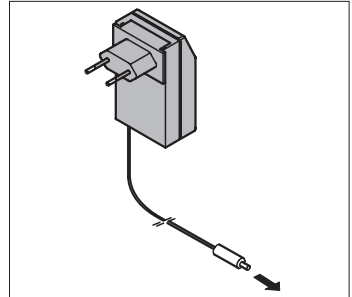

8.2.2 Voltage converter for the vehicle

The voltage converter does not need particular care or maintenance. Nevertheless, check your voltage converter regularly and protect it from oil, grease, aggressive cleaners, diluting agents and/or damage due to sharp edges, etc.

Service and repairs on the voltage converter may only be done by authorized personnel.

Please adhere closely to the enclosed voltage converter's operator's manual.

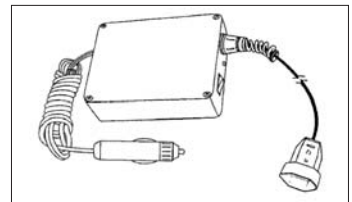

8.3 Battery pack

The battery pack's sealed lead acid batteries should be recharged after each use. (Technical details for the sealed lead acid batteries you find in chapter 8.3.1).

- 👉 If the *S-max* is at a standstill for some time, please connect it to the charger to retain the charge. This does not damage the sealed lead acid batteries, on the contrary, it increases their durability.

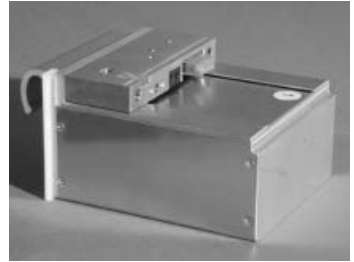

8.3.1 Sealed lead acid batteries

There are 2 sealed lead acid batteries 12 V / 3,3 Ah in the battery pack of the *S-max*. These batteries are sealed, maintenance free, re-chargeable and of top quality.

The durability of sealed lead acid batteries depends primarily on the charge/discharge cycle. For instance, you may discharge them partially more than 1000 times and use up the entire capacity more than 200 times, if you avoid a total discharge entirely.

- 👉 Please avoid a total discharge

A total discharge does not only lead to a loss of the batteries' capacity, but also shortens their durability. Thus, do avoid a total discharge, by recharging the batteries whenever possible!

- 👉 Charging your batteries is taking good care of them

If fully charged batteries run empty faster as usual, then they are probably used up. In such case please have them checked and, if necessary, replaced by Alber Antriebstechnik or its representative.



8.3.2 Charging the battery pack

The battery pack may be charged either by means of the charging socket (1) on the device or, if pulled out, by means of the battery pack's socket (2) itself.

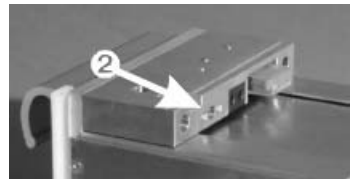

8.3.3 Charging with the automatic charger

1. Plug in the connector ④ of the automatic charger to the socket on the *S-max* ① or on the battery pack ②
2. Plug in the connector ③ to the the wall outlet and the batteries are being charged.

The LED on the automatic charges indicates the charging process.

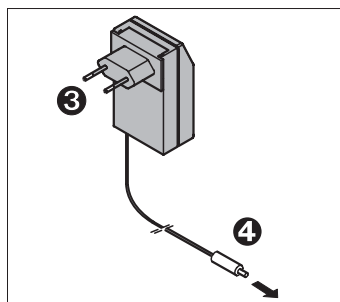

Signals of the charger

LED	batteries
red	are being charged
green	are charged, retaining of the charge

8.3.4 Charging with the voltage converter for the vehicle

1. Put the charger's plug ② either into the socket on the battery pack or the socket on the *S-max* (please see chapter 8.3.2).
2. Then put the plug ① of the automatic charger into the 230 V socket of ④ the voltage converter.
3. Put the 12 V connector ③ into the cigarette lighter.
4. Turn on the voltage converter by pushing the switch ⑤ and the battery pack is being charged.

A control light (LED) on the charger and a beeper in the voltage converter allow the charging process to be monitored.

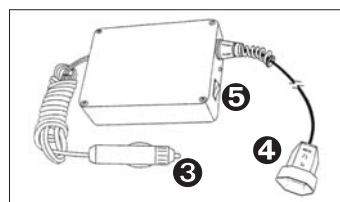
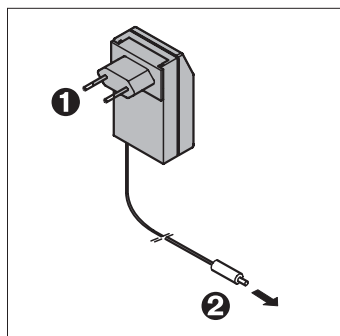

Signals of the charger and the voltage converter

Charger	LED, red	batteries are being charged
Charger	LED, green	batteries are charged, retaining of the charge
Voltage converter	beeping	12 V supply is low

8.4 Electrical fuse

The battery pack is equipped with a 30 A fuse protected by a cover **1**.

 You may not mend or by-pass a defect fuse. Always replace it with an identical one of the same amperage.

To exchange the fuse, remove the cover **2** and pull out the fuse **3**; insert the new one and replace the cover.

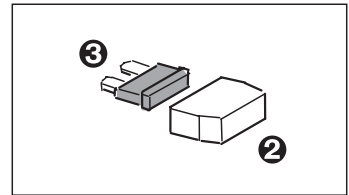
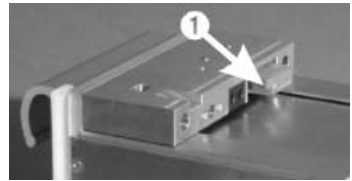

8.5 Brake lining

Please check the thickness of the safety brakes' lining ❶ regularly. The minimum thickness is 1 mm. In case the lining is thinner than 1 mm ❷, the lining must be exchanged on both sides. Please contact AAT Alber Antriebstechnik GmbH or your local dealer.

👉 Please check the safety brakes before each use of *the S-max* (see also chapter 4.2 and 6.4).

The safety brakes, particularly the knurled surface of the brake drums in the wheel rims, must be cleaned weekly with alcohol to ensure the optimum braking effect.

👉 Never use suds or greasy cleaners.

After cleaning the safety brakes must be checked as described in chapter 6.4.

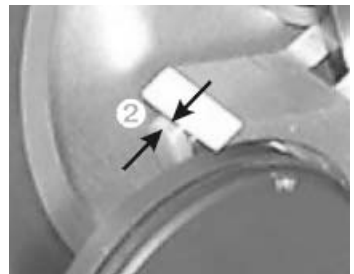

8.6 Check/exchange the climber's rollers

Please also check the roller's lining on a regular basis.

👉 If the lining is worn or broken, please have both rollers exchanged.



8.7 Cleaning

All parts of the *S-max* - except the safety brakes (see chapter 4.2) - can be cleaned with a moist cloth; please use regular mild household cleaners.

👉 Please always use a merely moist cloth to clean the device to avoid water penetrating the *S-max*.

👉 For safety reasons, please do not use a high-pressure cleaning device.

9 Warranty and liability

9.1 Warranty

AAT Alber Antriebstechnik GmbH grants a warranty of two years for all its products of type **S-max** including all its accessory parts (with the exception of the sealed lead acid batteries). The warranty begins at the date of purchase and covers failure of material and errors in manufacturing.

For the sealed lead acid batteries, always assuming correct maintenance, AAT Alber Antriebstechnik GmbH grants a warranty of six months from the date of purchase.

The warranty of the **S-max** does not cover damage or failure caused by:

- inadequate and insufficient maintenance by the client
- inadmissible changes or improper use
- improper use extending the maximum loading capacity of the **S-max**
- inappropriate charging of the sealed lead acid batteries batteries.

9.2 Liability

AAT Alber Antriebstechnik GmbH, manufacturer of the **S-max**, is not responsible for eventual damage done by the following:

- **S-max** was used inappropriately
- repair work, assembly and the like was done by unauthorized personnel
- **S-max** was not operated in accordance with this user's manual
- extraneous parts were attached to or used with the **S-max**.
- parts of the **S-max** were removed
- lower and upper rods as well as the rings of the **S-max** were not adapted correctly to the wheel chair
- the **S-max** was loaded extending the maximum loading capacity.



AAT Alber Antriebstechnik GmbH

Postfach 10 05 60 · D-72426 Albstadt
Tel.: +49 - 74 31 - 12 95 0 · Fax.: +49 - 74 31 - 12 95 35
info@aat-gmbh.com

www.aat-gmbh.com